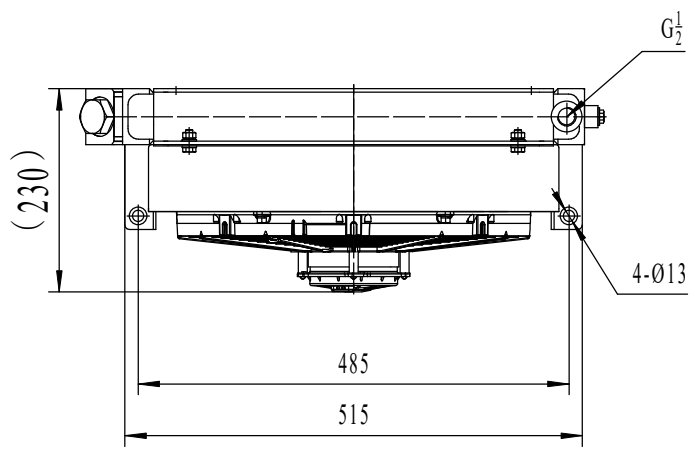
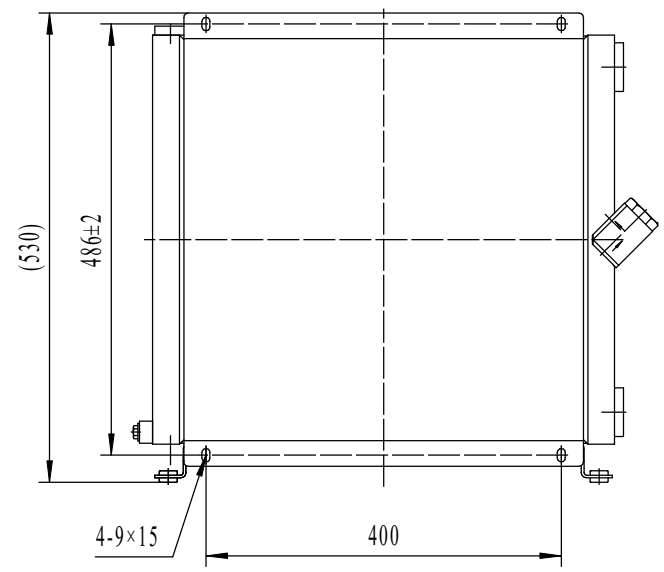
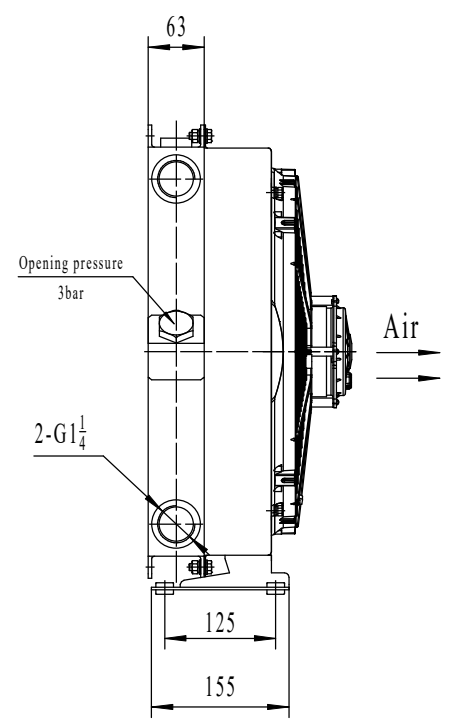
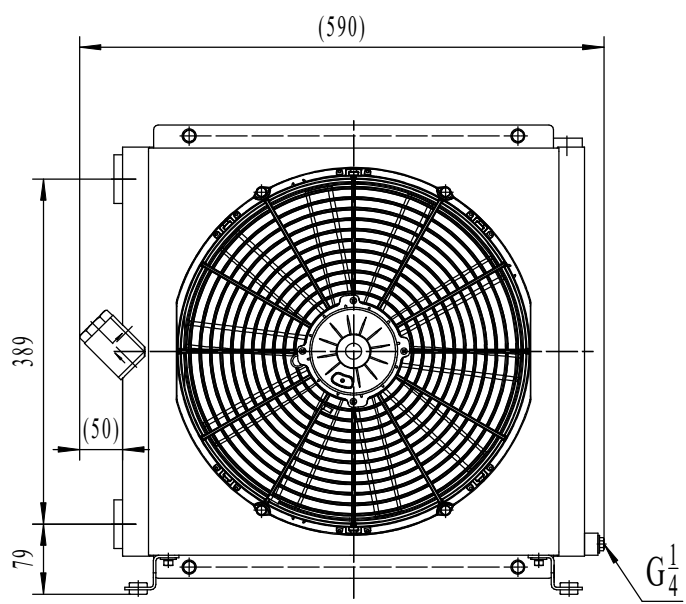

Table of tolerances for welding and non machined surface							surface roughness	
Nominal dimension	First		>300	>600	>1000	>2000	heat treatment	
	End	300	600	1000	2000	3000	surface treatment	
Allowable tolerance		±1	±1.5	±2	±3	±4	general tolerance	HB5800-99



Technical requirement:

1. The products are designed, manufactured and tested in accordance with NB/T47006-2009 aluminum plate fin heat exchanger;
2. Before the assembly, the thread of each connection is smooth; all bolts are fastened and free of looseness;
3. The oil cooler surface spray silver paint, steel components spray black powder;
4. Airtight test pressure 2.5MPa, keep pressure for 5 minutes, no leakage and deformation, clean and dry inner cavity, each pipe seal.

	SCALE	1:6		
Oil Cooler				
AH-T16-B-24DC				